

befame

Bellissa



Corner sofas

Available in a left-hand or right-hand configuration. The sets below are left-hand facing.

BELLISSA SET 1

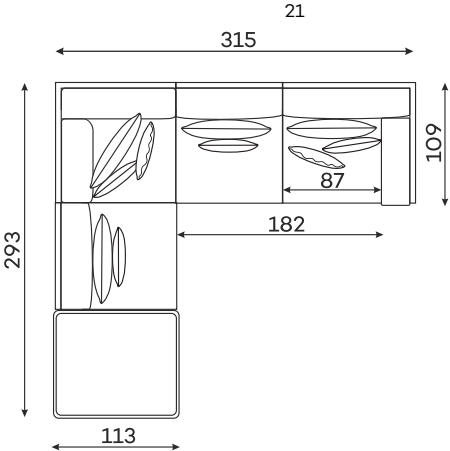

BELLISSA SET 2

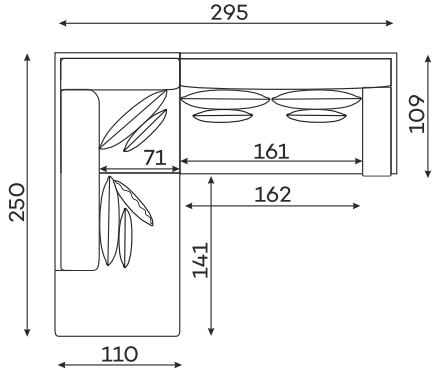

BELLISSA SET 3

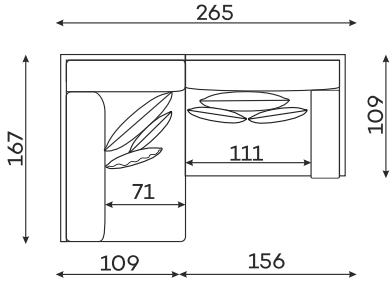

BELLISSA SET 4

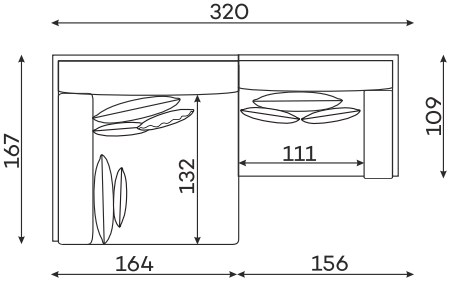

Sofas

2-SEATER SOFA

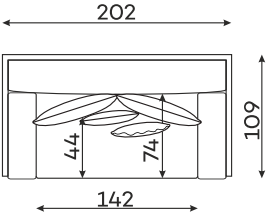

3-SEATER SOFA

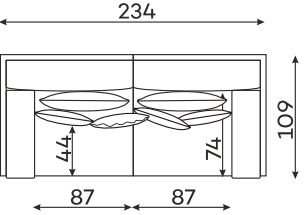

4-SEATER SOFA

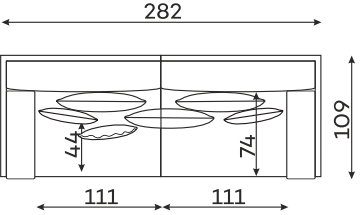

All dimensions of upholstered furniture are given with a tolerance of +/- 4 cm

Modular units

Available in a left-hand or right-hand configuration.

CORNER UNIT

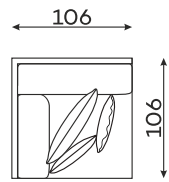

1,5-SEATER UNIT

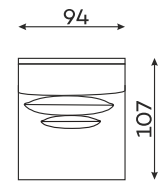

1,5-SEATER UNIT

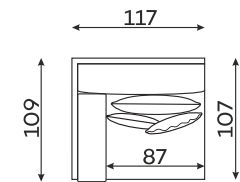

2-SEATER UNIT ARM UNIT

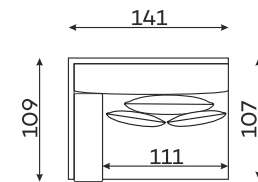

2,5-SEAT ONE ARM UNIT

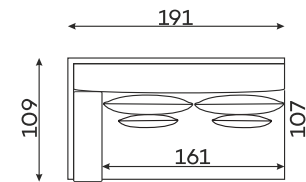

3-SEAT ONE ARM UNIT

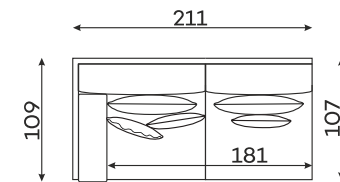

CHAISE UNIT XL

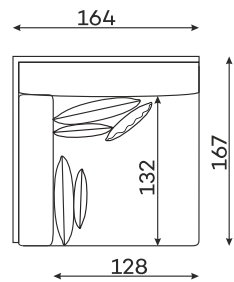

CHAISE UNIT L

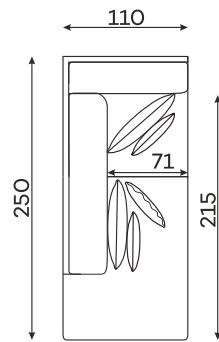

CHAISE UNIT M

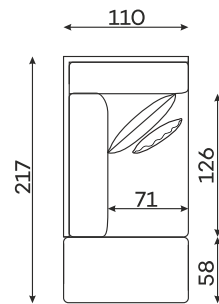

CHAISE UNIT S

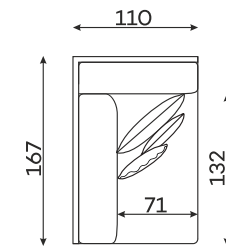

POUFFE

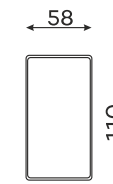

SMALL POUFFE

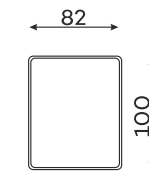

LARGE POUFFE

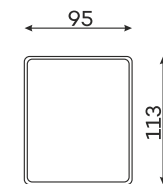

Pouffe height: 48

All dimensions of upholstered furniture are given with a tolerance of +/- 4 cm

Other dimensions

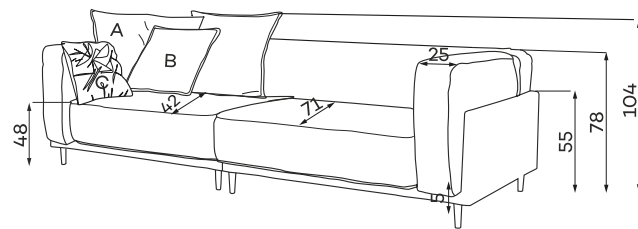

CUSHION (A)

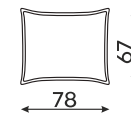

CUSHION (B)

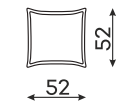

CUSHION (C)

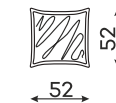

Leg colors available

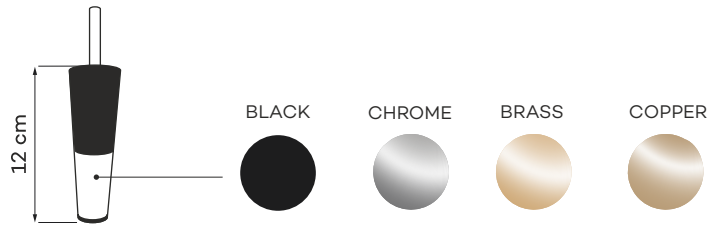

What makes the Bellissa sofa stand out?



Sinuous spring support – Enhanced seat flexibility, high-resilience foam cushioning, long-lasting comfort and durability.



Extensive fabric selection – Water-repellent finishes, easy-clean materials, exclusive collection options.

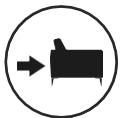

Fully upholstered design – 360-degree visual appeal, seamless aesthetic integration.

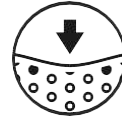

High-resilience foam core – Enhanced seat durability, improved elasticity, resistance to deformation.



Ergonomic seat and backrest – Natural body contour alignment, superior support, elevated comfort.



Modular design – Custom configurations, adaptable layout, seamless fit for any space.