



befame

Laurent

Laurent is Bellissa's younger brother – just like her it is made of modules, it also has soft and very comfortable seat cushions, thanks to a special combination of corrugated springs and highly flexible foam. Just by looking at it, you can imagine the comfort of resting on this piece of furniture. You can comfortably sit back and enjoy aromatic coffee and admire the views outside the window, or lie down under a warm blanket, accompanied by your favourite book or film. Laurent is slightly more versatile in style, making it easier to fit into various types of interiors. Its charm is enhanced by a decorative trim and loose decorative pillows.

Corner sofas

Available in a left-hand or right-hand configuration. The sets below are left-hand facing.

Laurent SET 1

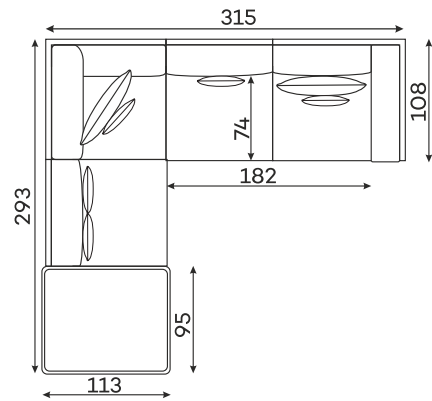

Laurent SET 2

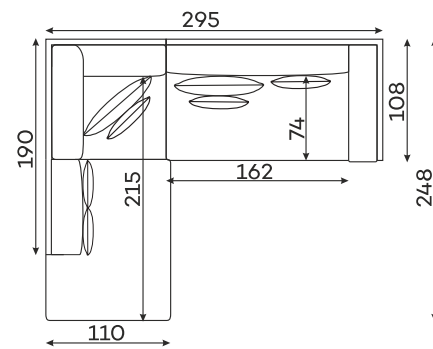

Laurent SET 3

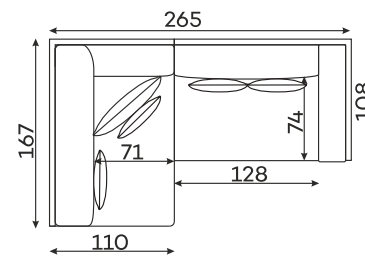

Laurent SET 4

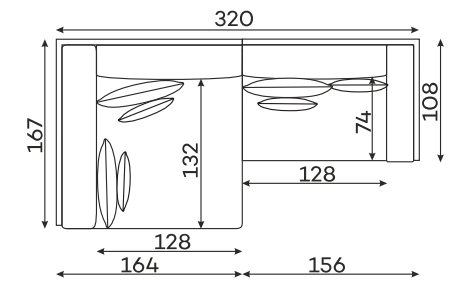

Sofas

2-SEATER SOFA WITHOUT SLEEPING FUNCTION (THE FURNITURE CONSISTS OF ONE ELEMENT.)

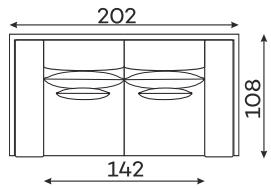

3-SEATER SOFA WITHOUT SLEEPING FUNCTION. CONSISTS OF (1,5-SEATER ONE ARM UNIT + 1,5-SEATER ONE ARM UNIT.)

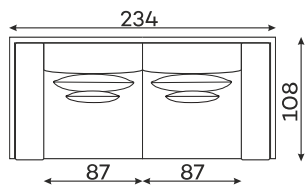

4-SEATER SOFA WITHOUT SLEEPING FUNCTION. CONSISTS OF (2-SEATER ONE ARM UNIT + 2-SEATER ONE ARM UNIT.)

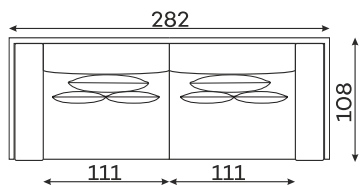

Modular units

Available in a left-hand or right-hand configuration. The sets below are left-hand facing.

CORNER ELEMENT

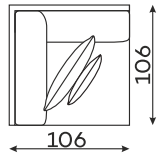

1,5-SEATER WITH ARMREST

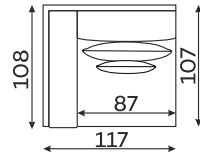

2-SEATER WITH ARMREST

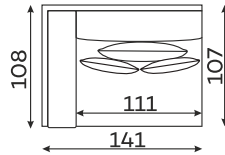

2,5-SEATER WITH ARMREST

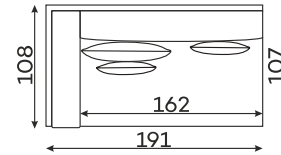

3-SEATER WITH ARMREST

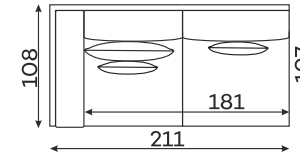

1,5-SEATER

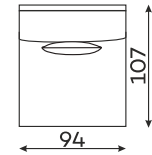

CHAISE LONGUE XL

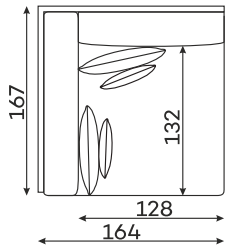

CHAISE LONGUE L

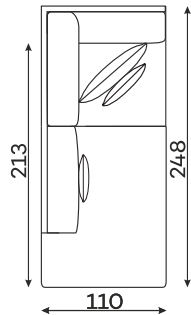

CHAISE LONGUE M

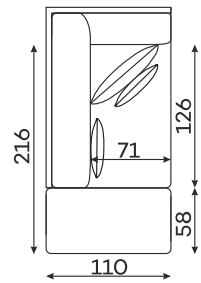

CHAISE LONGUE S

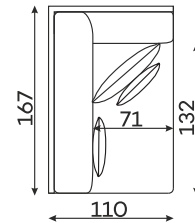

POUFFE



SMALL POUFFE

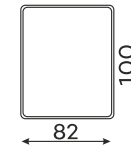

LARGE POUFFE

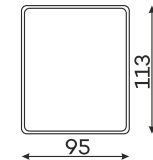

Pouffe height: 48

All dimensions of upholstered furniture are given with a tolerance of +/- 4 cm

Other dimensions

Noga A, wysokość 10 cm:

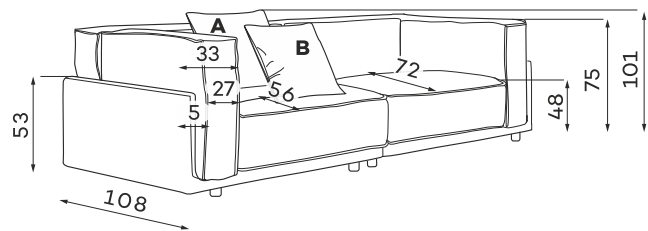

Noga B, wysokość 7 cm:

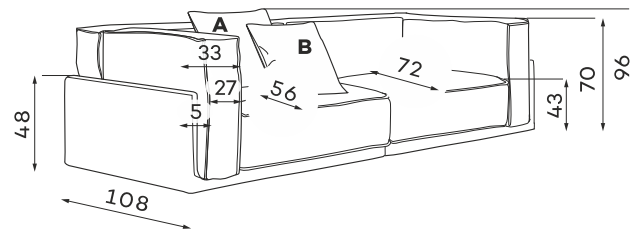

CUSHION (A)

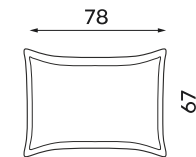

CUSHION (B)

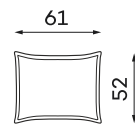

Leg colors available

Choose one of the two available legs, wood with gold or a version where the leg will be invisible.

Leg A, height 10 cm

BLACK
-BLACK



BLACK
-COPPER



BLACK
-CHROME



BLACK
-BRASS

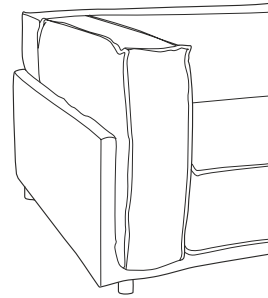

Leg B, height 7 cm - invisible

VENGE

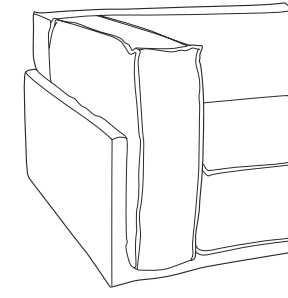

What makes the Laurent sofa stand out?



The sinuous springs make the seat more flexible and provide a perfect base for high-elastic foam.



You have the opportunity to choose a fabric from dedicated collections, including fabrics that are easy to clean.



The furniture is fully upholstered, so you can put it in the middle of the living room.



The collection offers several colours of legs. You decide what colour you want. Do you like them and want to buy them for your dresser, for example? Of course you can.



The perfect fit between the seat and backrest to the anatomical shape of the human body provides exceptional comfort and ergonomics of the body.



The highly elastic foam used increases the strength and elasticity of the seat preventing deformation.